



Mini
CHRISTEN EAGLE II
N54CE

MS: X104

ASSEMBLY MANUAL

“Graphics and specifications may change without notice”.



Specifications:

Wing span ----- 35.4in (90.0cm).
Wing area -----392.2sq.in (25.3sq dm).
Weight -----3.5lbs (1.6kg).
Length -----31.0in (78.8cm).
Speed control(ESC)-----30A-40A amp.
Motor ----- 480.
Radio ----- 4 channels with 4 mini servos.
Battery 2-3-cell 2200mAh to 2600mAh Li-Po.
10 x 5E Electric Prop.

INTRODUCTION.

Thank you for choosing the **MINI CHRISTEN EAGLE II N54CE** ARTF by SEAGULL MODELS COMPANY LTD. The **MINI CHRISTEN EAGLE II N54CE** was designed with the intermediate/advanced sport flyer in mind. It is a semi scale airplane which is easy to fly and quick to assemble. The airframe is conventionally built using balsa, plywood to make it stronger than the average ARTF, yet the design allows the aeroplane to be kept light. You will find that most of the work has been done for you already. The motor mount has been fitted and the hinges are pre-installed. Flying the **MINI CHRISTEN EAGLE II N54CE** is simply a joy.

This instruction manual is designed to help you build a great flying aeroplane. Please read this manual thoroughly before starting assembly of your **MINI CHRISTEN EAGLE II N54CE**. Use the parts listing below to identify all parts.

WARNING.

Please be aware that this aeroplane is not a toy and if assembled or used incorrectly it is capable of causing injury to people or property. WHEN YOU FLY THIS AEROPLANE YOU ASSUME ALL RISK & RESPONSIBILITY.

If you are inexperienced with basic R/C flight we strongly recommend you contact your R/C supplier and join your local R/C Model Flying Club. R/C Model Flying Clubs offer a variety of training procedures designed to help the new pilot on his way to successful R/C flight. They will also be able to advise on any insurance and safety regulations that may apply.

KIT CONTENTS



KIT CONTENTS.

SEAX10401	Fuselage
SEAX10402	Wing Set
SEAX10403	Tail Set
SEAX10404	Cowling
SEAX10405	Landing Gear Set
SEAX10406	Canopy Hatch
SEAX10407	Wing Tube
SEAX10408	Hardware
SEAX10409	Pushrod Set

ADDITIONAL ITEMS REQUIRED.

- Motor 480
- 4 channel radio with 4 mini servos
- Speed control (ESC) 30A-40A amp.
- Battery 2-3-cell 2200mAh to 2600mAh Li-Po.

TOOLS & SUPPLIES NEEDED.

- Thick cyanoacrylate glue
- 30 minute epoxy
- 5 minute epoxy
- Hand or electric drill
- Assorted drill bits
- Modelling knife
- Straight edge ruler
- 2mm ball driver
- Phillips head screwdriver
- 220 grit sandpaper
- 90° square or builder's triangle
- Wire cutters
- Masking tape & T-pins
- Thread-lock
- Paper towels

HINGING THE AILERONS .

Note: *The control surfaces, including the ailerons, elevators, and rudder, are prehinged with hinges installed, but the hinges are not glued in place. It is imperative that you properly adhere the hinges in place per the steps that follow using a high-quality thin C/A glue.*

- 1) Carefully remove the aileron from one of the wing panels. Note the position of the hinges.

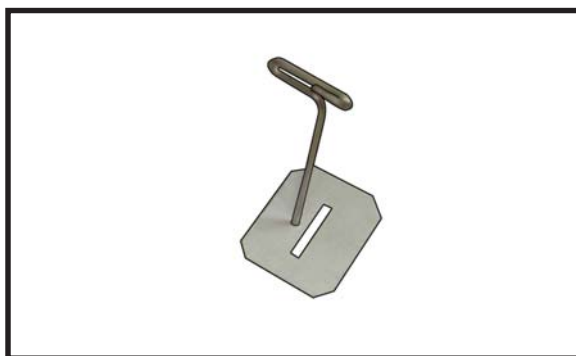

- 2) Remove each hinge from the wing panel and aileron and place a T-pin in the center of each hinge. Slide each hinge into the aileron until the T-pin is snug against the aileron. This will help ensure an equal amount of hinge is on either side of the hinge line when the aileron is mounted to the wing panel.

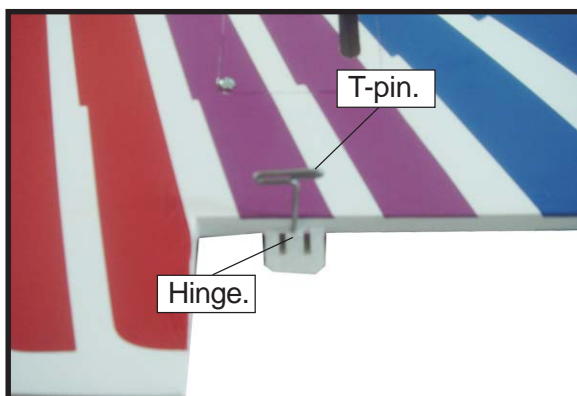

- 3) Slide the aileron on the wing panel until there is only a slight gap. The hinge is now centered on the wing panel and aileron. Remove the T-pins and snug the aileron against the wing panel. A gap of 1/64" or less should be maintained between the wing panel and aileron.



- 4) Deflect the aileron and completely saturate each hinge with thin C/A glue. The aileron's front surface should lightly contact the wing during this procedure. Ideally, when the hinges are glued in place, a 1/64" gap or less will be maintained throughout the length of the aileron to the wing panel hinge line.

Note: *The hinge is constructed of a special material that allows the C/A to wick or penetrate and distribute throughout the hinge, securely bonding it to the wood structure of the wing panel and aileron.*

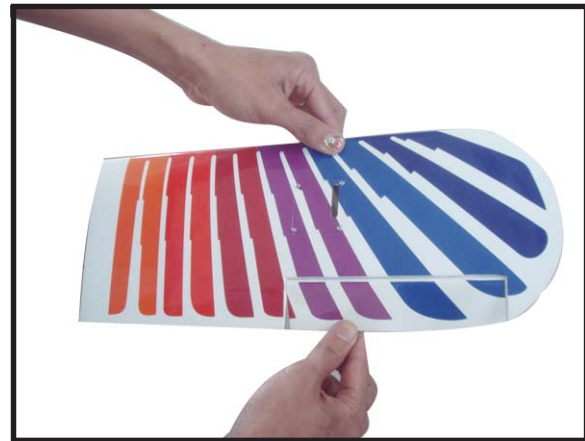
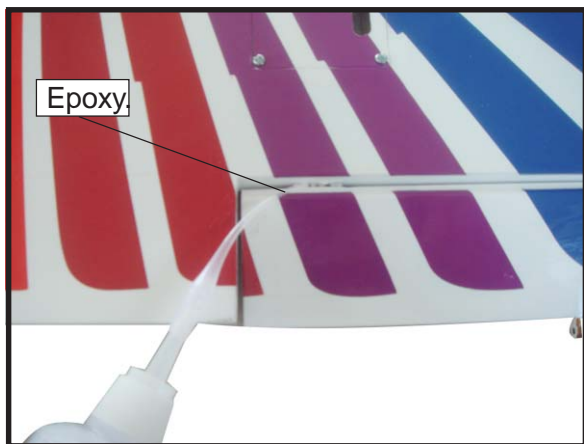

- 5) Turn the wing panel over and deflect the aileron in the opposite direction from the opposite side. Apply thin C/A glue to each hinge, making sure that the C/A penetrates into both the aileron and wing panel.
- 6) Using C/A remover/debonder and a paper towel, remove any excess C/A glue that may have accumulated on the wing or in the aileron hinge area.
- 7) Repeat this process with the other wing panel, securely hinging the aileron in place.
- 8) After both ailerons are securely hinged, firmly grasp the wing panel and aileron to make sure the hinges are securely glued and cannot be pulled out. Do this by carefully applying medium pressure, trying to separate the aileron from the wing panel. Use caution not to crush the wing structure.

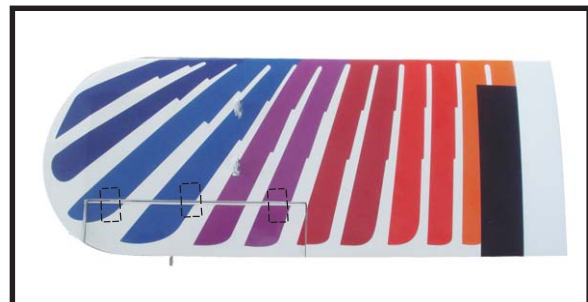

Note: *Work the aileron up and down several times to "work in" the hinges and check for proper movement.*

HINGING THE ELEVATORS.

1) Locate the items for this section of the manual.



2) Carefully remove the elevator from one of the horizontal stabilizer panels. Note the position of the hinges. Used C/A glue to fix the hinge position.

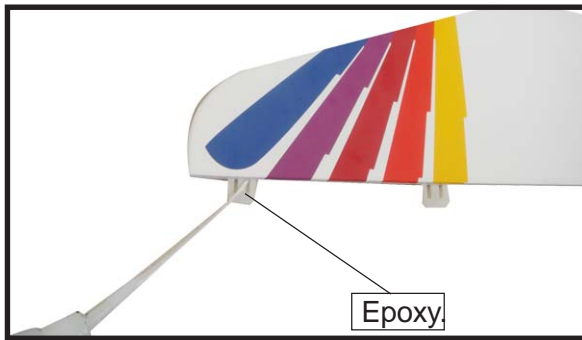

3) Remove each hinge from the horizontal stabilizer panel and elevator and place a T-pin in the center of each hinge. Slide each hinge into the elevator until the T-pin is snug against the elevator. This will help ensure an equal amount of hinge is on either side of the hinge line when the elevator is mounted to the horizontal stabilizer panel.

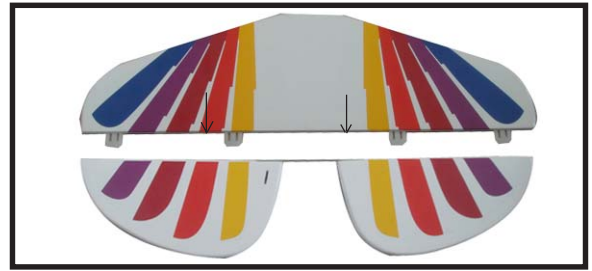
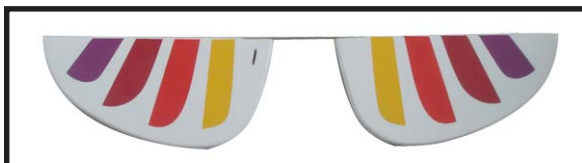
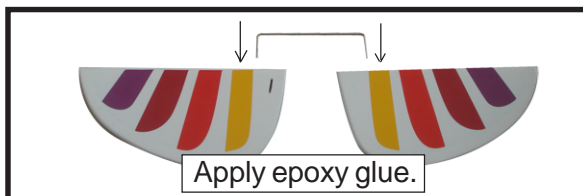

Glue the elevator hinges in place using the same techniques used to hinge the ailerons.

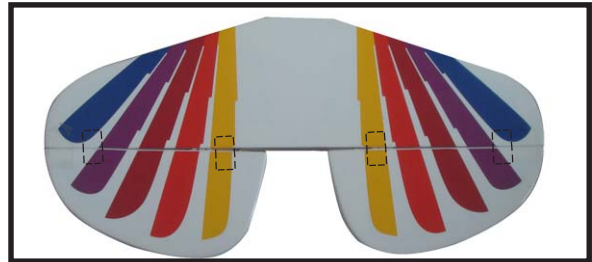

HINGING THE RUDDER.

Glue the rudder hinges in place using the same techniques used to hinge the ailerons.

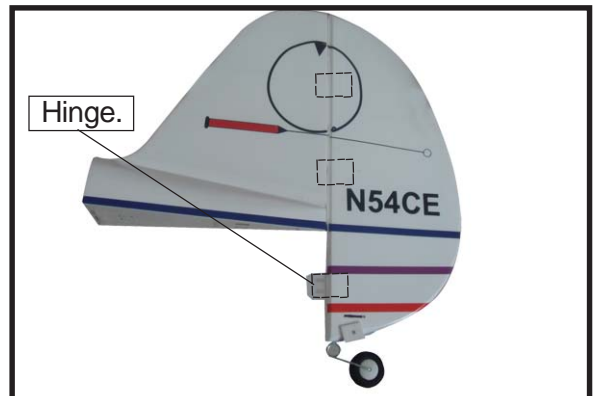

INSTALL THEAILERONS CONTROL HORN.

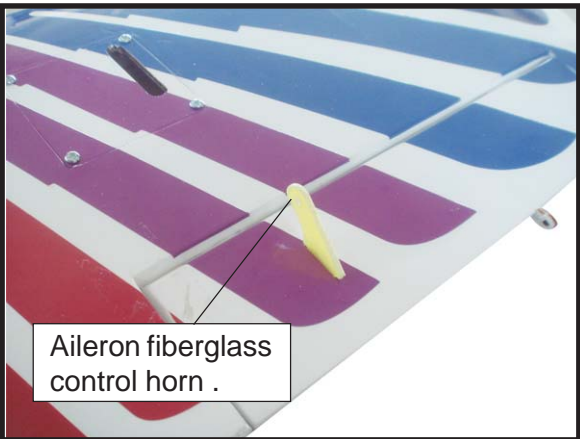
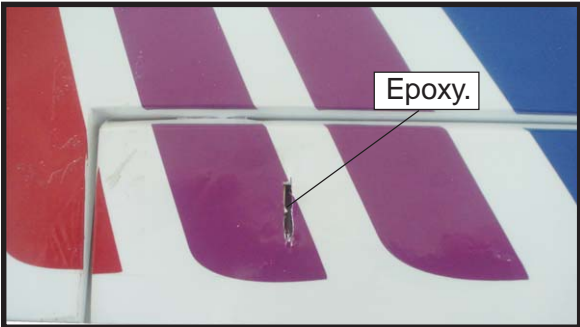

INSTALL ELEVATOR CONTROL HORN.

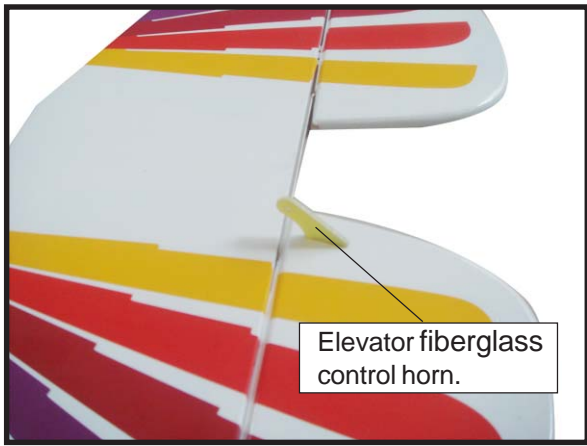
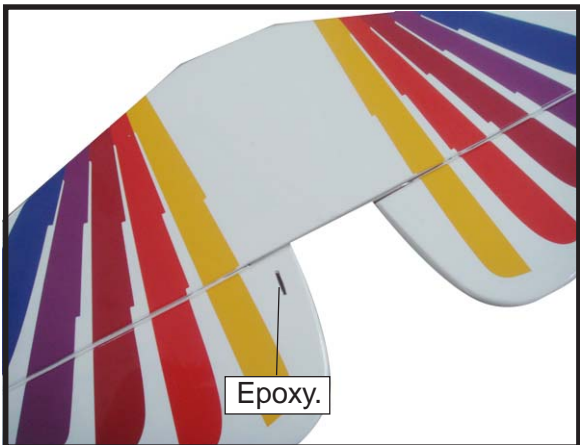

INSTALL RUDDER CONTROL HORN.

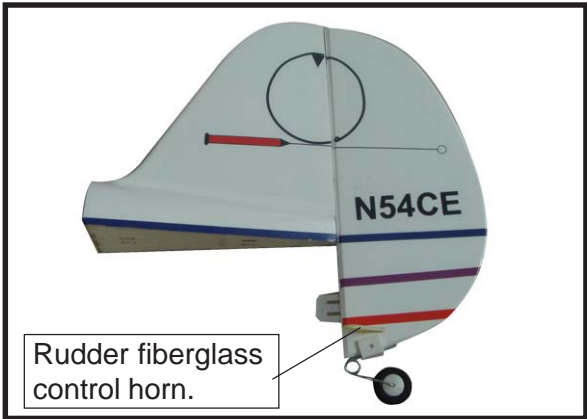
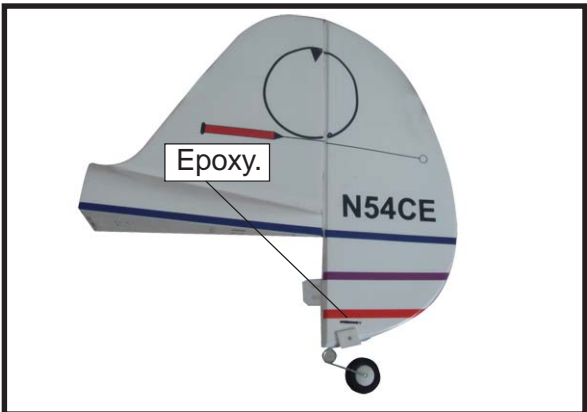

INSTALLING THE FUSELAGE SERVOS.

 *Because the size of servos differ, you may need to adjust the size of the precut opening in the mount. The notch in the sides of the mount allow the servo lead to pass through.*

□ 1) Secure the servos with the screws provided with your radio system.

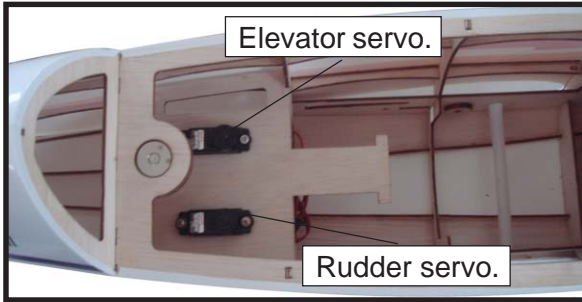

FUSELAGE SERVO ARM INSTALLATION.

Install adjustable servo connector in the servo arm as same as picture below:

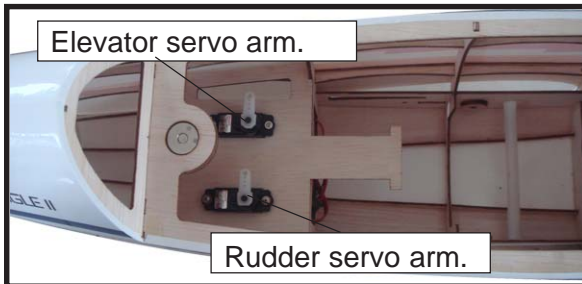

WHEEL AND WHEEL PANTS ASSEMBLY.

□ 1) Assembling and mounting the wheel pants to the landing gear as shown below pictures.



□ 2) Follow diagram below for wheel pant installation:

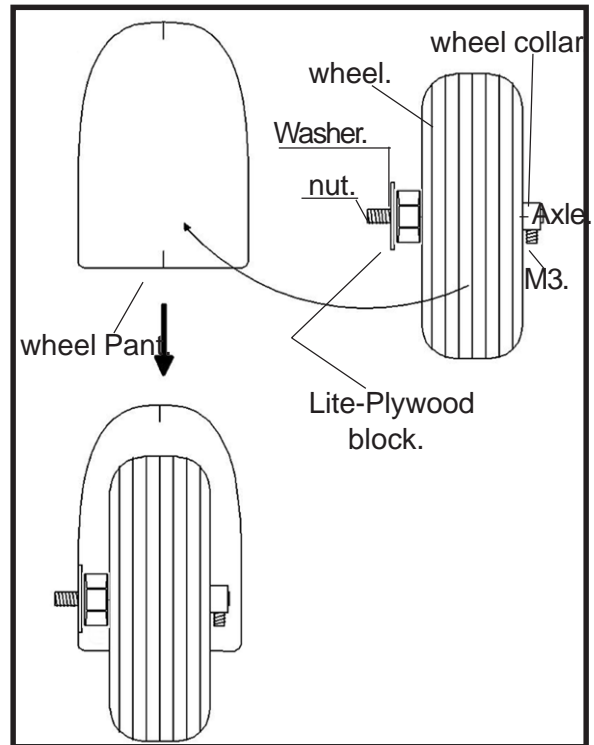

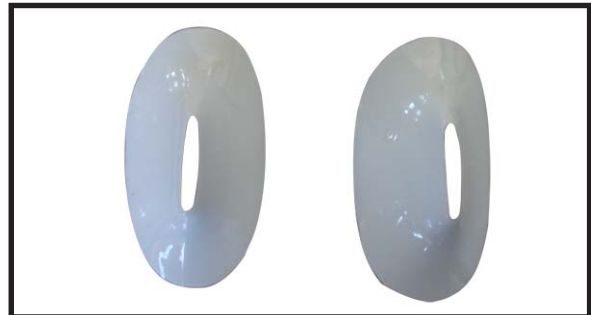
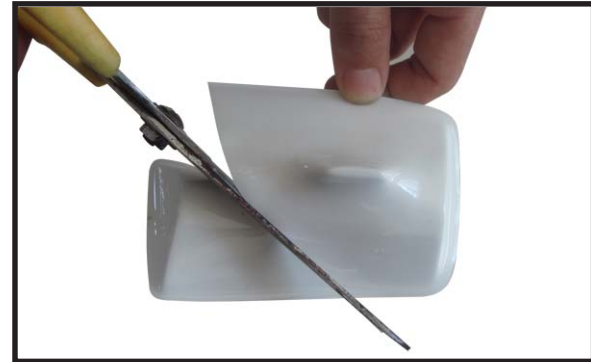

□ 4) A drop of C/A glue on the wheel collar screws will help keep them from coming loose during operation.

Repeat the process for the other wheel and wheel pant.

INSTALLING THE MAIN LANDING GEAR TO FUSELAGE.

□ 5) The blind nuts for securing the landing gear are already mounted inside the fuselage.

□ 6) Using the hardware provided, mount the main landing gear to the fuselage.

□ 7) Place the fuselage inverted on the workbench in a suitable stand. Set the landing gear in place and use a screwdriver to secure the landing gear to the fuselage using bolts M3x10mm and washers. Make sure to use the threadlock on the bolts so they don't vibrate loose.

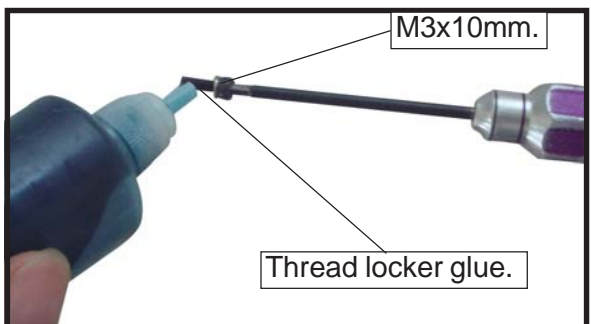
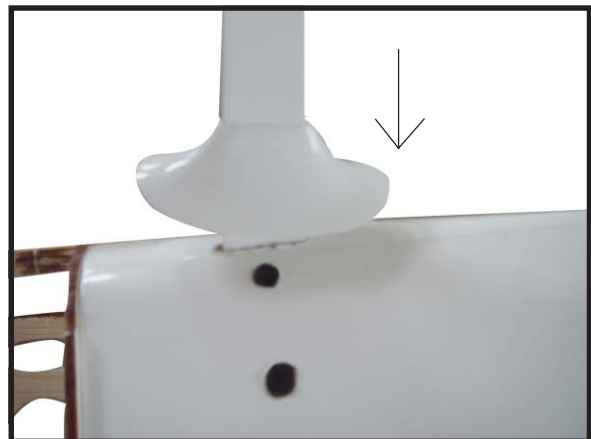

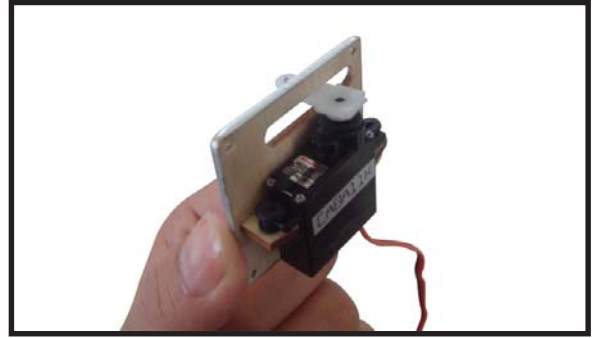
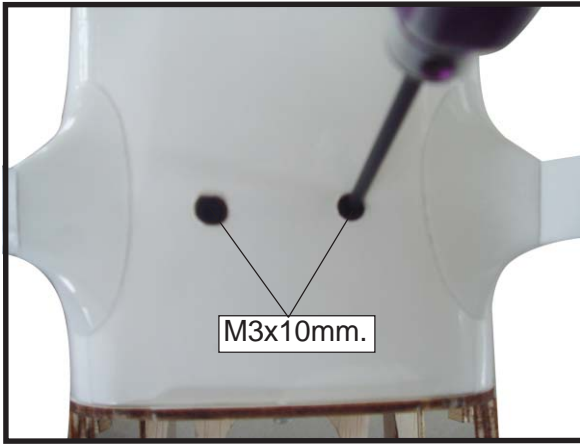

3) Use drill bit in a pin vise to drill the mounting holes in the blocks.

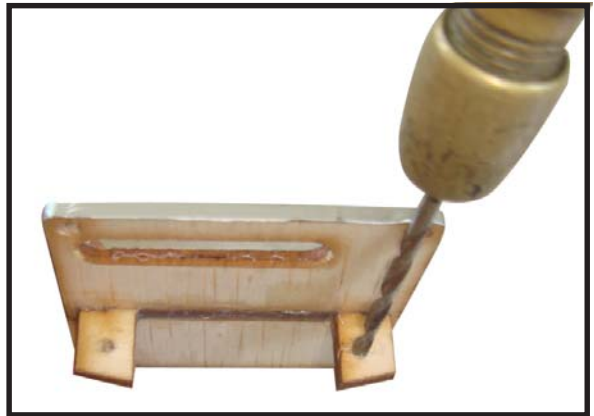
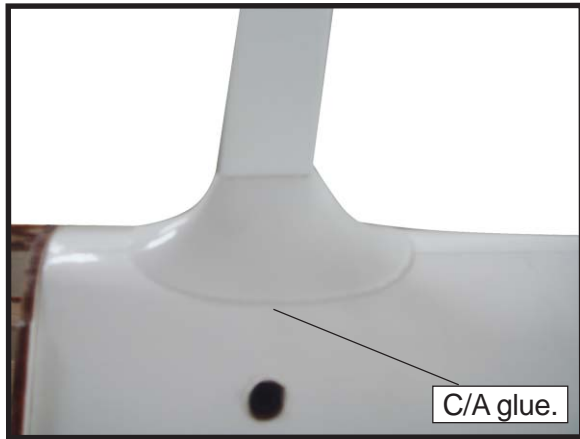

4) Apply 2-3 drops of thin C/A to each of the mounting holes. Allow the C/A to cure without using accelerator.

INSTALLING THE AILERON.

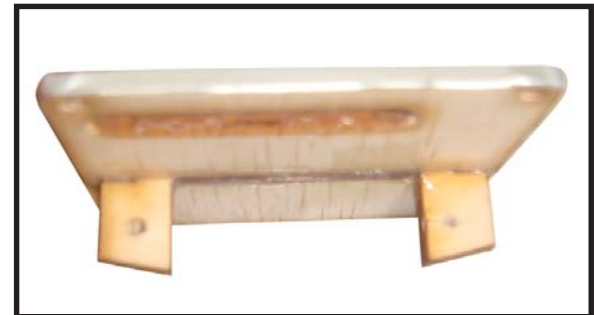
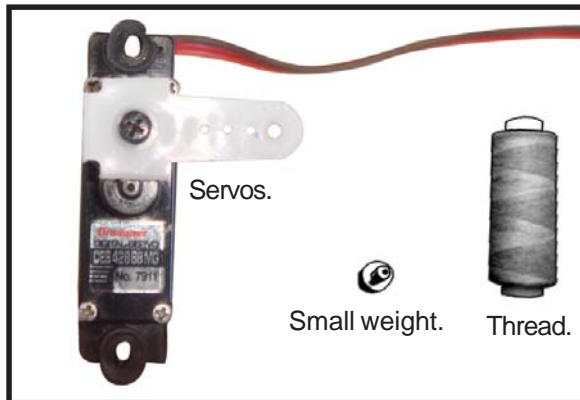

5) Use dental floss to secure the connection so they cannot become unplugged.

! *Because the size of servos differ, you may need to adjust the size of the precut opening in the mount. The notch in the sides of the mount allow the servo lead to pass through.*

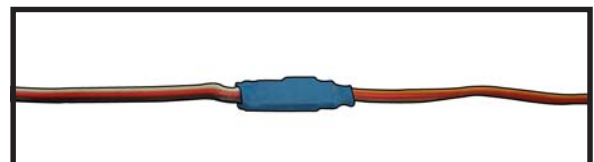

1) Using a small weight (*Weighted fuel pick-up works well*) and string, feed the string through the wing as indicated.

6) Secure the servo to the aileron hatch using Phillips screwdriver and the screws provided with the servo.

2) Place the servo between the mounting blocks and space it from the hatch. Use a pencil to mark the mounting hole locations on the blocks.

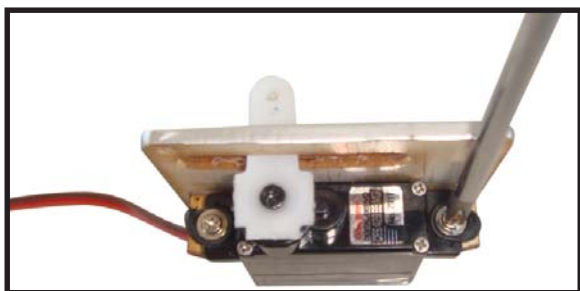

7) Apply 1-2 drops of thin C/A to each of the mounting tabs. Allow the C/A to cure without using accelerator.

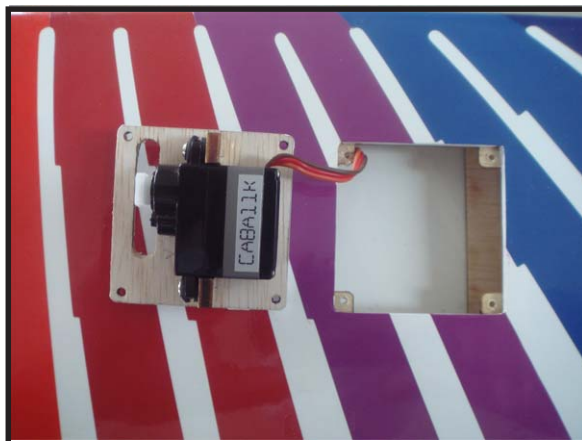

9) Set the aileron hatch in place and use a Phillips screw driver to install it with four wood screws.



8) A string has been provided in the wing to pull the aileron lead through to the wing root. Remove the string from the wing at the servo location and use the tape to attach it to the servo extension lead. Pull the lead through the wing and remove the string.

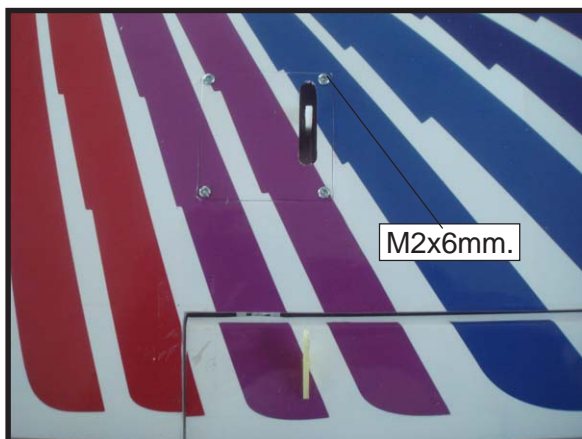
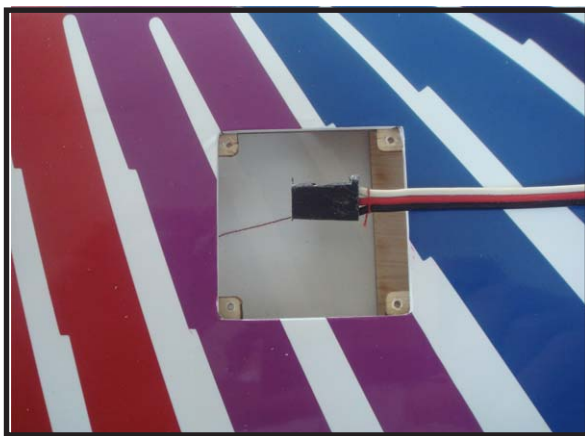
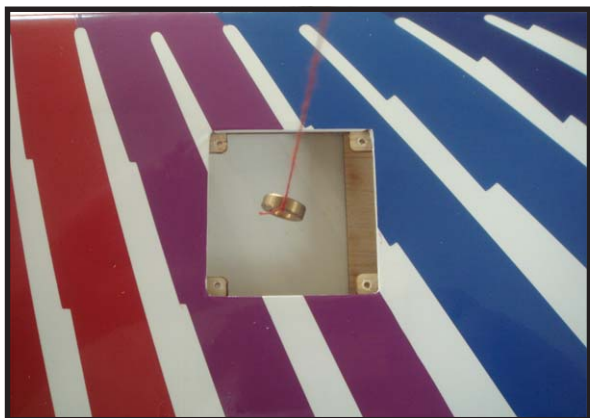
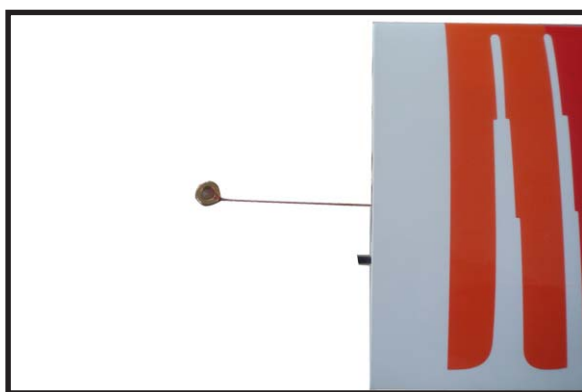

ELECTRIC POWER ASSEMBLY.

1) Locate the items necessary to install the electric power installation.

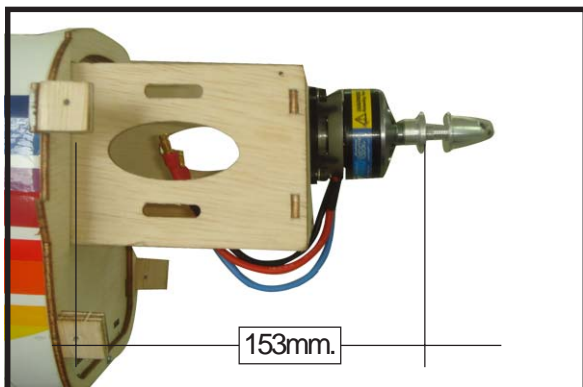
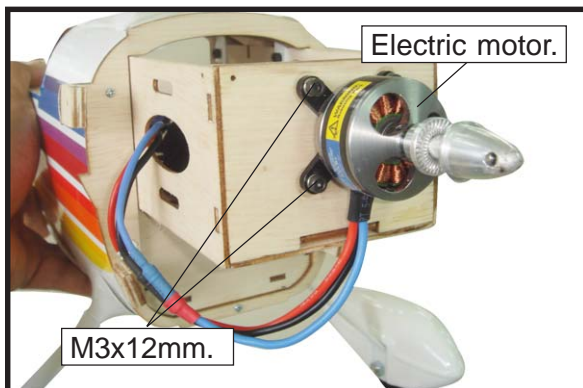
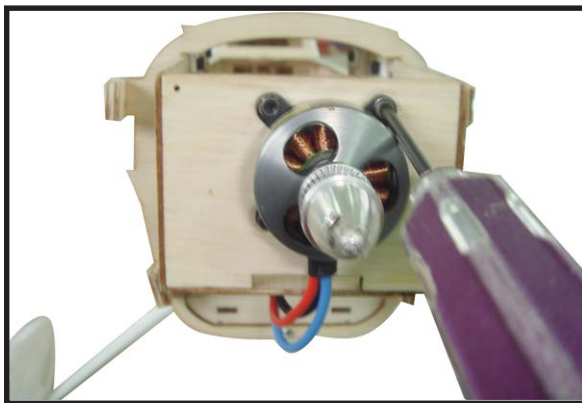
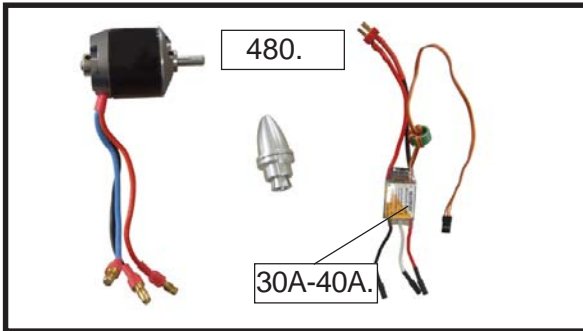

2) Locate the plywood battery tray to the fuselage.

3) Attach the speed control to the side of the motor box using two-sided tape and tie wraps. Connect the appropriate leads from the speed control to the motor. Make sure the leads will not interfere with the operation of the motor.

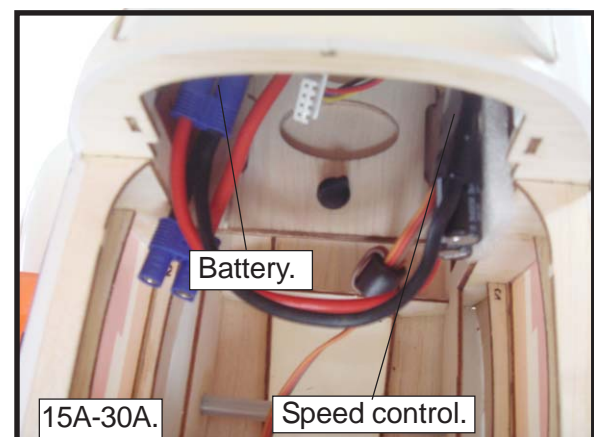
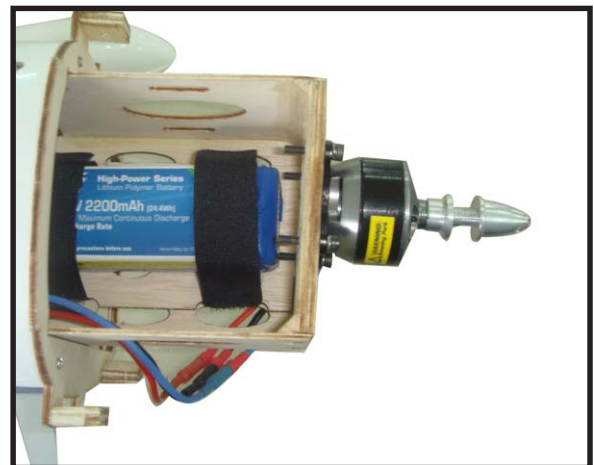
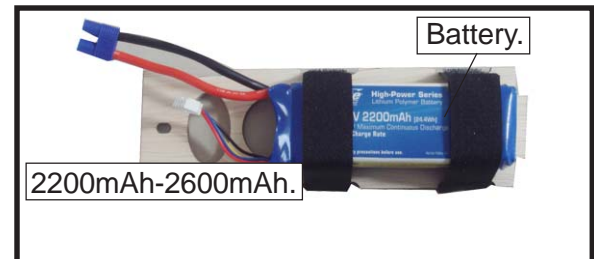
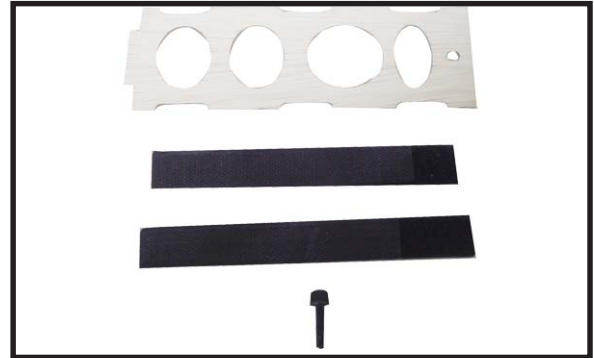

COWLING.

- 1) Slide the fiberglass cowl over the motor and line up the back edge of the cowl with the marks you made on the fuselage then trim and cut as shown.



- 2) While keeping the back edge of the cowl flush with the marks, align the front of the cowl with the crankshaft of the engine. The front of the cowl should be positioned so the crankshaft is in **nearly** the middle of the cowl opening. Use the spinner backplate as a guide. Hold the cowl firmly in place using pieces of masking tape.

- 3) Use four M2x6mm machine screws to secure the fiberglass cowl to the fuselage as shown.

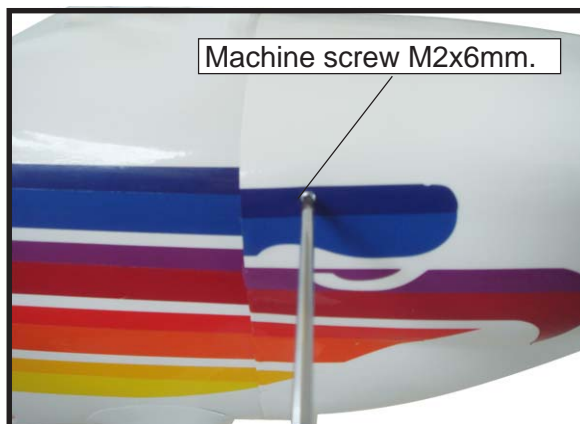

INSTALLING THE SPINNER.

Install the spinner backplate, propeller and spinner cone.



 *The propeller should not touch any part of the spinner cone. If it does, use a sharp modeling knife and carefully trim away the spinner cone where the propeller comes in contact with it.*



INSTALLING THE HORIZONTAL STABILIZER.

□ 1) Using a ruler and a pen, locate the centerline of the horizontal stabilizer, at the trailing edge, and place a mark. Use a triangle and extend this mark, from back to front, across the top of the stabilizer. Also extend this mark down the back of the trailing edge of the stabilizer.

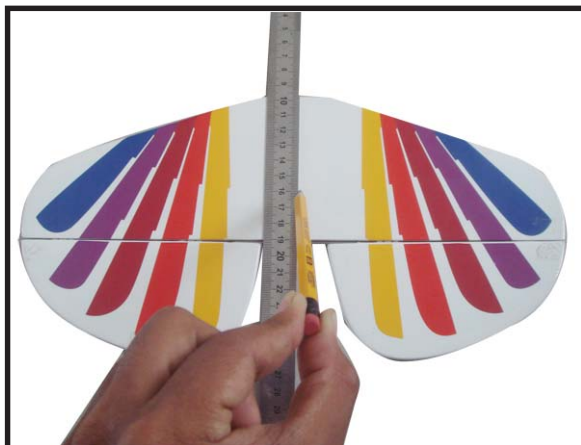

□ 2) Using a modeling knife, carefully remove the covering at mounting slot of horizontal stabilizer (both side of fuselage).



□ 3) Put the stabilizer into place in the position of the fuselage.

□ 4) Install the stabilizer onto the fuselage. Align the centerline drawn on the top and the rear of the stabilizer with the centre of the fuselage. When that is aligned, hold the stabilizer in that position using T-pins or masking tape. Align the horizontal stabilizer with the wing. When viewed from the rear, the horizontal stabilizer should be level with the wing. If it is not level, use sandpaper and sand down the high side of the stabilizer mounting platform until the proper alignment is achieved. The tips of the stabilizer should also be equal distance from the tips of the wing.

□ 5) When you are satisfied with the alignment, hold the stabilizer in place with T-pins or masking tape, but do not glue at this time.

□ 6) With the stabilizer held firmly in place, use a pen and draw lines onto the stabilizer where it and the fuselage sides meet. Do this on both the right and left sides and top and bottom of the stabilizer.



□ 7) Remove the stabilizer. Using the lines you just drew as a guide, carefully remove the covering from between them using a modeling knife.

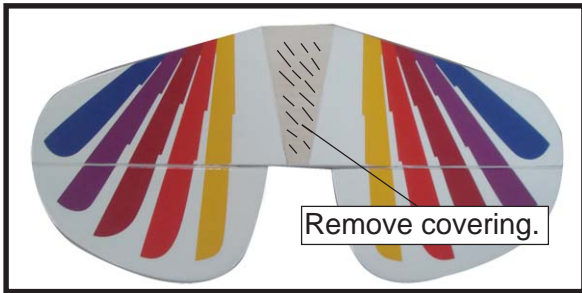

⚠ *When cutting through the covering to remove it, cut with only enough pressure to only cut through the covering itself. Cutting into the balsa structure may weaken it.*

□ 8) Using a modeling knife, carefully remove the covering that overlaps the stabilizer mounting platform sides in the fuselage. Remove the covering from both the top and the bottom of the platform sides.

□ 9) When you are sure that everything is aligned correctly, mix up a generous amount of 30 Minute Epoxy. Apply a thin layer to the bottom of the stabilizer mounting area and to the stabilizer mounting platform sides in the fuselage. Putting the stabilizer in place and realign. Double check all of your measurements once more before the epoxy cures. Hold the stabilizer in place with T-pins or masking tape and remove any excess epoxy using a paper towel and rubbing alcohol.

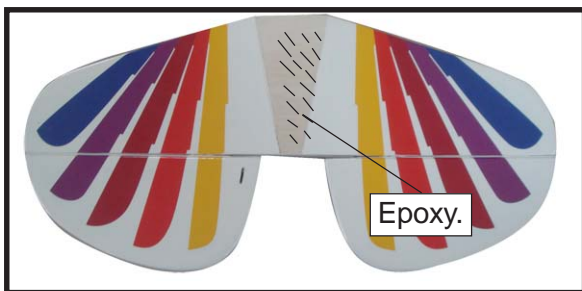

□ 10) After the epoxy has fully cured, remove the masking tape or T-pins used to hold the stabilizer in place. Carefully inspect the glue joints. Use more epoxy to fill in any gaps that may exist that were not filled previously and clean up the excess using a paper towel and rubbing alcohol.

INSTALLING THE VERTICAL STABILIZER.



1) Using a modeling knife, remove the covering from over the precut hinge slot cut into the lower rear portion of the tail at the fuselage.

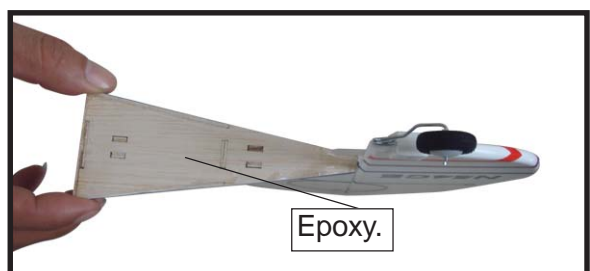

2) While holding the vertical stabilizer firmly in place, use a pen and draw a line on each side of the vertical stabilizer where it meets the top of the fuselage.



3) Slide the vertical stabilizer back in place. Using a triangle, check to ensure that the vertical stabilizer is aligned 90° to the horizontal stabilizer.

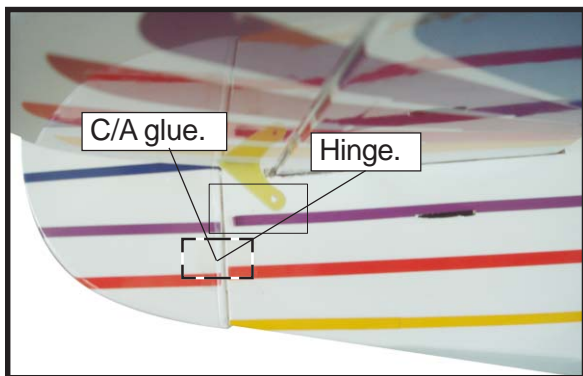
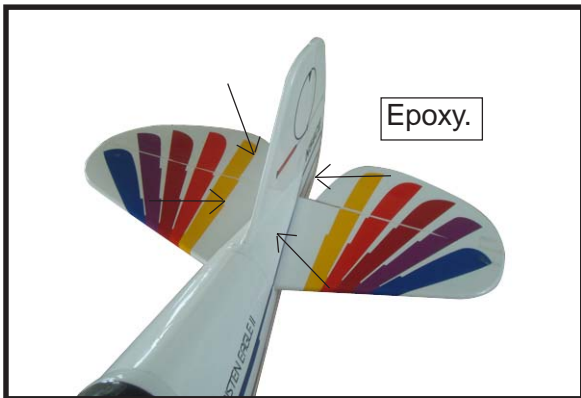
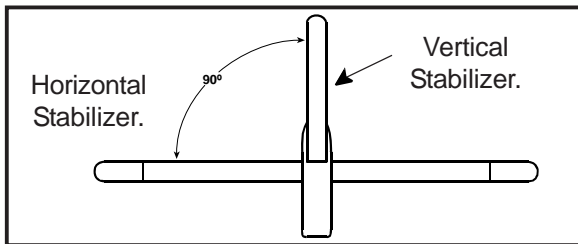

4) When you are sure that everything is aligned correctly, mix up a generous amount of Flash 30 Minute Epoxy. Apply a thin layer to the mounting slot and to bottom of the vertical stabilizer mounting area. Apply epoxy to the bottom and top edges of the filler block and to the lower hinge also. Set the stabilizer in place and realign. Double check all of your measurements once more before the epoxy cures. Hold the stabilizer in place with T-pins or masking tape and remove any excess epoxy using a paper towel and rubbing alcohol. Allow the epoxy to fully cure before proceeding.



ELEVATOR - RUDDER PUSHROD HORN INSTALLATION.

- 1) Install the elevator control horn using the same method as with the aileron control horns.
- 2) Position the elevator control horn on the both side of elevator.



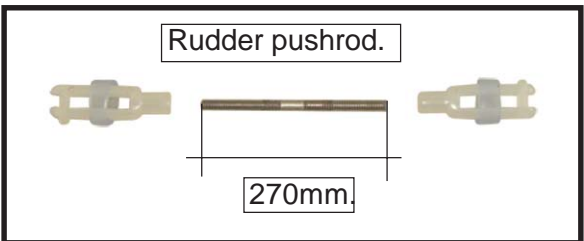
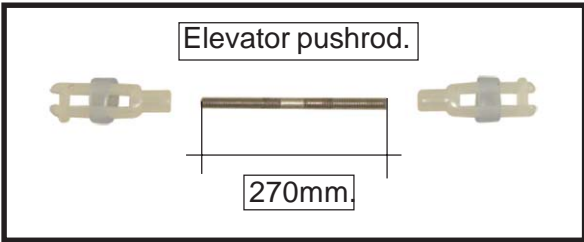

AILERON PUSHROD HORN INSTALLATION

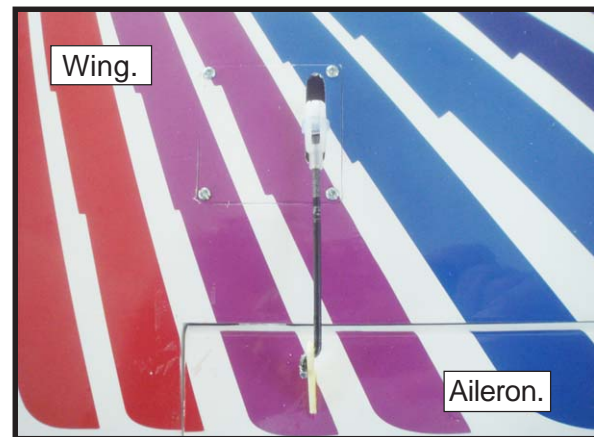
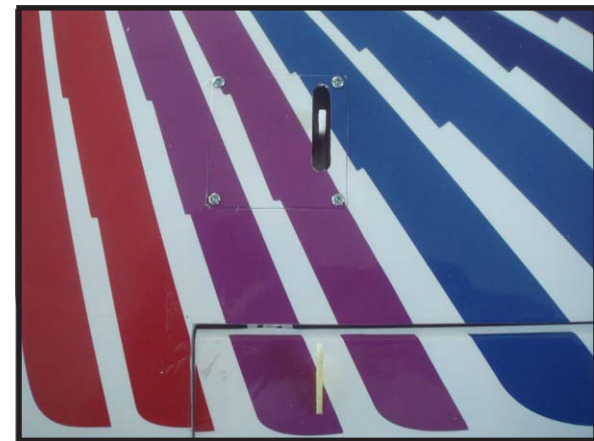
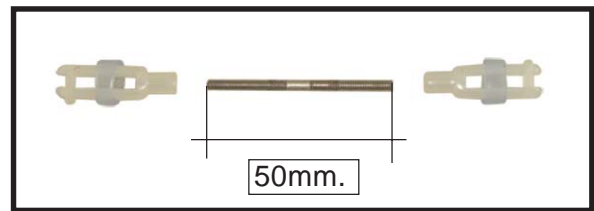

CABANE STRUT INSTALLATION

1) Locate the items for this section of the manual.

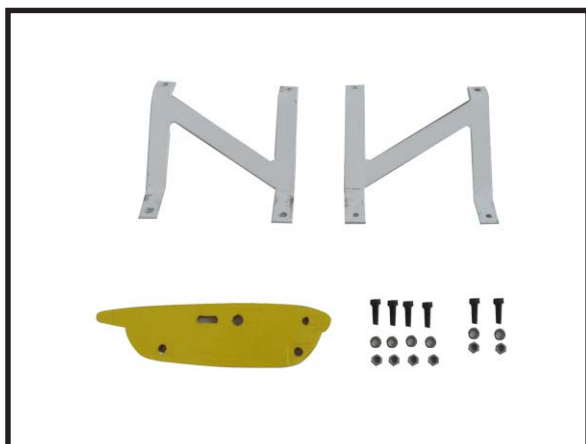

2) Use a hobby knife with blade to remove the covering on the top of the fuselage so the cabane struts can be inserted into the fuselage. We recommend using a trim seal tool to iron the covering neatly into the openings in the fuselage .



3) Place the cabane struts on position ,noting their position as shown in the photo.Loosely install the four M3x6 socket head machine screws and M3 washers.Leave , the hardware loose so the struts can be positioned while installing the upper wing center rib.Maker sure to use threadlock on the screws so they won't vibrate loose.



4) Place the upper center wing rib in position on the cabane struts.Start the M3x12 socket head screws that secure the rib to the cabane struts.

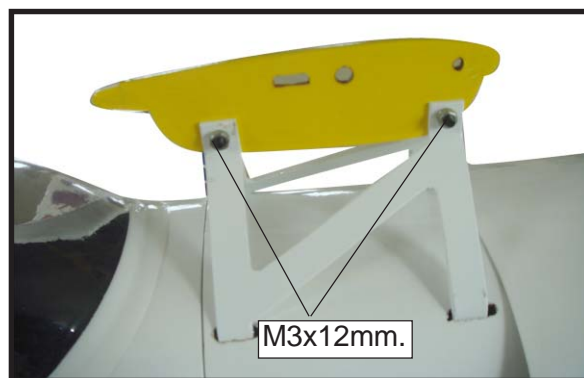

5) Use a 2.5mm hex wrench to slowly tighten the hardware securing the cabane struts in position on the fuselage.You may want to use hemostats to hold the M3 nuts when using them to attach the upper center wing rib to the struts .Again ,make sure to use threadlock on all the fasteners to prevent them from vibrating loose.

INSTALLING THE RECEIVER.

- ❑ 1) Plug the five servo leads and the switch lead into the receiver. Plug the battery pack lead into the switch also.
- ❑ 2) Wrap the receiver pack in the protective foam rubber to protect them from vibration.
- ❑ 3) Route the antenna in the antenna tube inside the fuselage and secure it to the bottom of fuselage using a plastic tape.

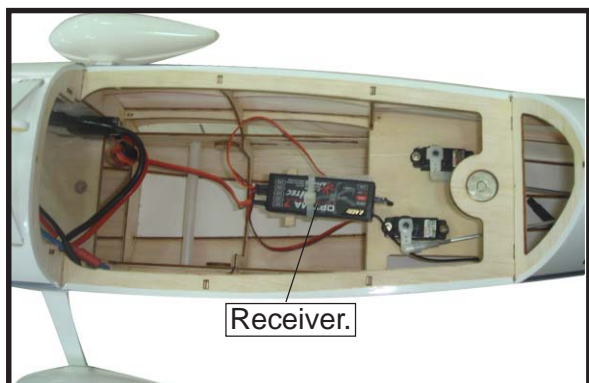
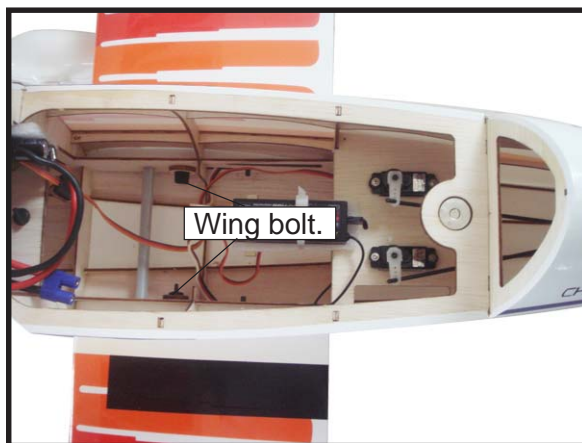

ATTACHMENT WING-FUSELAGE.

Attach the carbon fiber into fuselage.

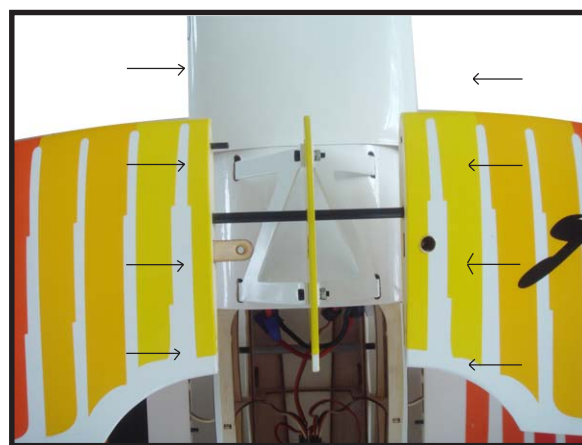
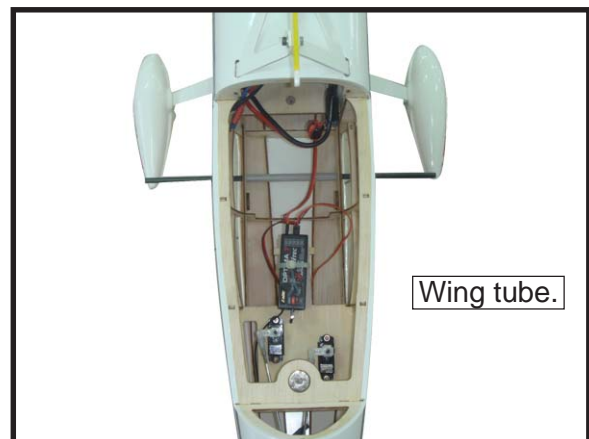
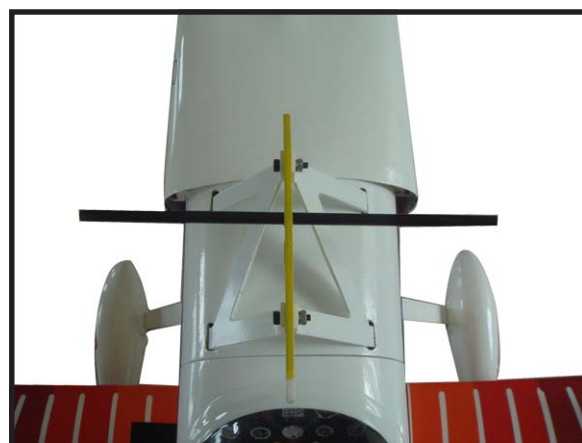

Insert two wing panels as pictures below.

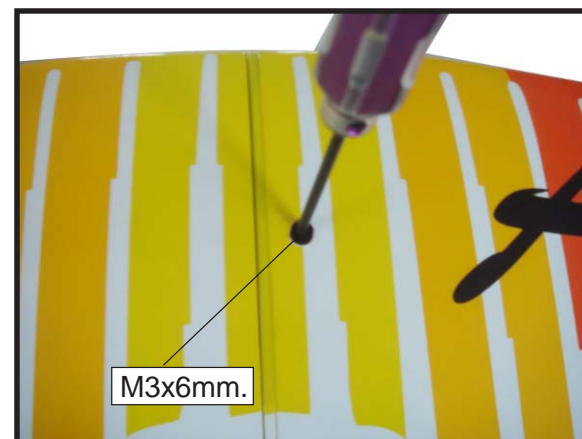
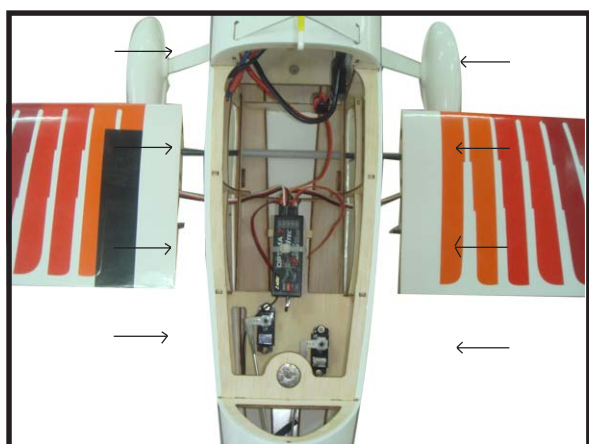

Place the Fuselage Hatch back on the fuselage to complete the assembly of your models.

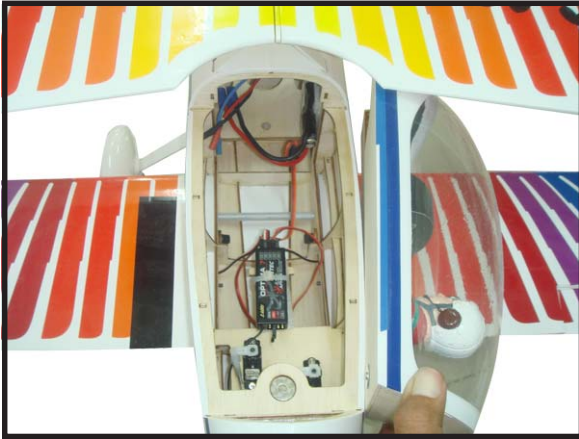

INSTALLATION WING STRUTS.

1) Locate the items for this section of the manual.

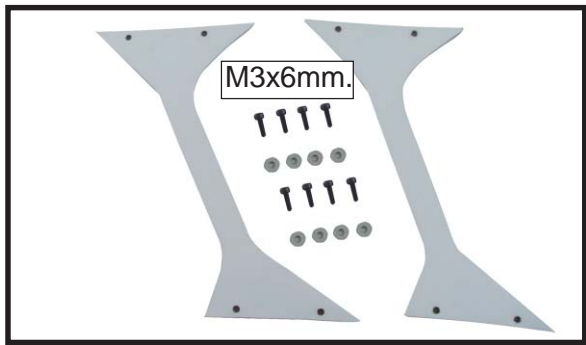

2) Attach the wing strut to the top of the bottom wing panel using an M3x6 machine screw.



3) Repeat steps to prepare the remaining wing panel for installation.



3) Thread a clevis on each end of a threaded rod. Connect the rod between the top and bottom ailerons. With the radio system on and the bottom aileron centered, adjust the length to center the top aileron. Once centered, slide the silicone tubing over the forks of the clevis to prevent it from opening accidentally. Apply threadlock on the nuts and clevises to prevent them from vibrating loose. Use needle nose pliers to tighten the nut against the clevis to prevent it from vibrating and changing position.

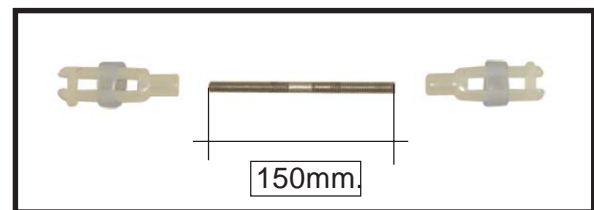
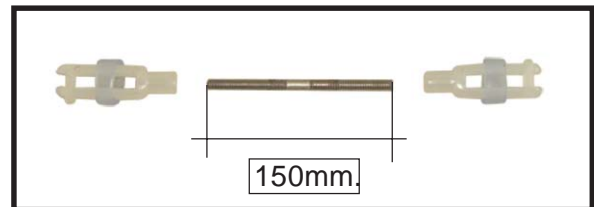



BALANCING.

□ 1) It is critical that your airplane be balanced correctly. Improper balance will cause your plane to lose control and crash. THE CENTER OF GRAVITY IS LOCATED **75MM** BACK FROM THE LEADING EDGE OF THE WING AT THE WING ROOT.

□ 2) Mount the wing to the fuselage. Using a couple of pieces of masking tape, place them on the top side of the wing **75mm** back from the leading edge of the wing at the wing root.

□ 3) Turn the airplane upside down. Place your fingers on the masking tape and carefully lift the plane .

Accurately mark the balance point on the top of the wing on both sides of the fuselage. The balance point is located **75mm** back from the leading edge of the wing at the wing root. This is the balance point at which your model should balance for your first flights. Later, you may wish to experiment by shifting the balance up to 10mm forward or back to change the flying characteristics. Moving the balance forward may improve the smoothness and arrow- like tracking, but it may then require more speed for take off and make it more difficult to slow down for landing. Moving the balance aft makes the model more agile with a lighter and snappier "feel". In any case, please start at the location we recommend .

With the wing attached to the fuselage, all parts of the model installed (ready to fly), and empty fuel tanks, hold the model at the marked balance point with the stabilizer level..

Lift the model. If the tail drops when you lift, the model is "tail heavy" and you must add weight* to the nose. If the nose drops, it is "nose heavy" and you must add weight* to the tail to balance.

*If possible, first attempt to balance the model by changing the position of the receiver battery and receiver. If you are unable to obtain good balance by doing so, then it will be necessary to add weight to the nose or tail to achieve the proper balance point.

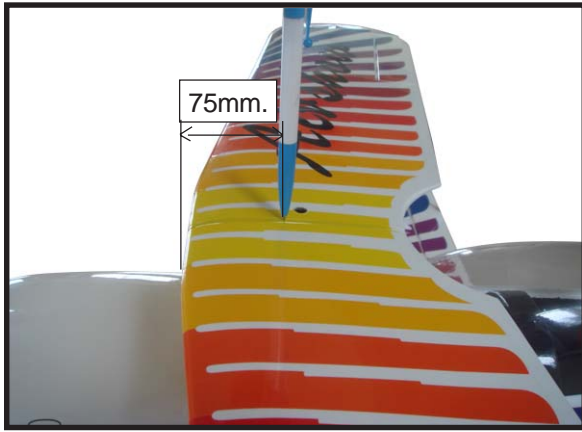

CONTROL THROWS.

Ailerons:

High Rate :

Up : 15 mm

Down : 15 mm

Low Rate :

Up : 10 mm

Down : 10 mm

Rudder:

High Rate :

Right : 30 mm

Left : 30 mm

Low Rate :

Right : 20 mm

Left : 20 mm

Elevator:

High Rate :

Up : 15 mm

Down : 15 mm

Low Rate :

Up : 10 mm

Down : 10 mm

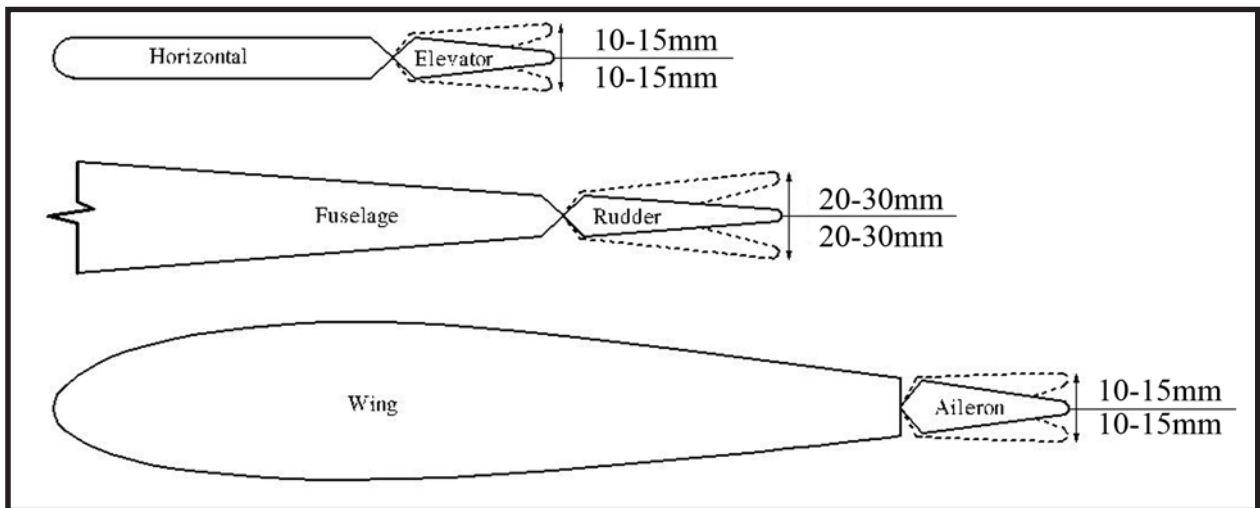

FLIGHT PREPARATION.

Check the operation and direction of the elevator, rudder, ailerons and throttle.

- A) Plug in your radio system per the manufacturer's instructions and turn everything on.
- B) Check the elevator first. Pull back on the elevator stick. The elevator halves should move up. If they do not, flip the servo reversing switch on your transmitter to change the direction.
- C) Check the rudder. Looking from behind the airplane, move the rudder stick to the right. The rudder should move to the right. If it does not, flip the servo reversing switch on your transmitter to change the direction.
- D) Check the throttle. Moving the throttle stick forward should open the carburetor barrel. If it does not, flip the servo reversing switch on your transmitter to change the direction.
- E) From behind the airplane, look at the aileron on the right wing half. Move the aileron stick to the right. The right aileron should move up and the other aileron should move down. If it does not, flip the servo reversing switch on your transmitter to change the direction.

PREFLIGHT CHECK.

- 1) Completely charge your transmitter and receiver batteries before your first day of flying.
- 2) Check every bolt and every glue joint in the **MINI CHRISTEN EAGLE II N54CE** to ensure that everything is tight and well bonded.
- 3) Double check the balance of the airplane. Do this with the fuel tank empty.
- 4) Check the control surfaces. All should move in the correct direction and not bind in any way.
- 5) If your radio transmitter is equipped with dual rate switches double check that they are on the low rate setting for your first few flights.
- 6) Check to ensure the control surfaces are moving the proper amount for both low and high rate settings.
- 7) Check the receiver antenna. It should be fully extended and not coiled up inside the fuselage.
- 8) Properly balance the propeller. An out of balance propeller will cause excessive vibration which could lead to engine and/or airframe failure.

We wish you many safe and enjoyable flights with your MINI CHRISTEN EAGLE II N54CE.